

CORNELL

REAL ESTATE

REVIEW

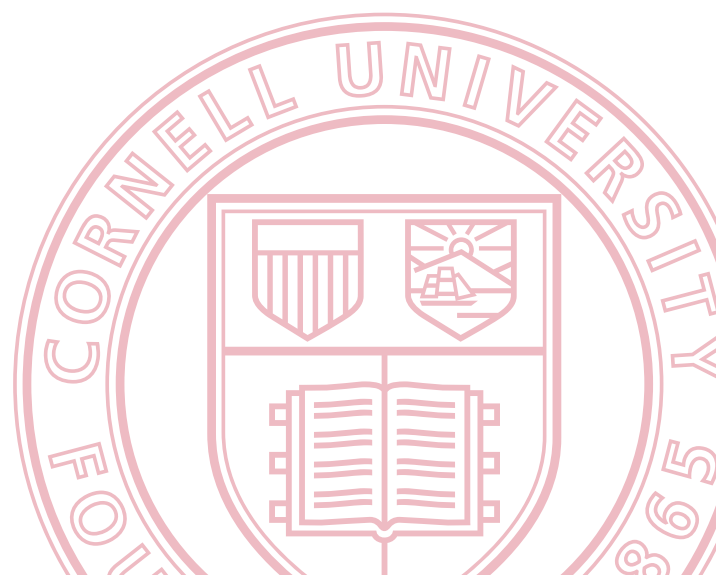

Cornell University
Baker Program in Real Estate



The Value of Flexibility: A Finance Application of Options to Real Estate

By: Hamid Pezeshkian, Sina Lashgari, and Duane Stiller

Author

Hamid Pezeshkian earned his bachelor's in Entrepreneurship/Venture Management and Finance from the University of Oklahoma. Fascinated by the inherent level of innovation in real estate, Hamid assisted the founding team of a green residential developer while an undergraduate in Oklahoma. He later joined Oklahoma City's top Coldwell Banker Commercial (CBC) office as an Investment Sales specialist, where he worked directly with private investors to make numerous Retail and Office investment acquisitions. During his first year at CBC, Hamid earned several Top Producer awards at the company, and was also sponsored by the local Certified Commercial Investment Member (CCIM) chapter. Hamid then attended the Cornell's Baker Program in Real Estate, and during that time held a summer internship as an acquisition associate at Urban American, a multifamily investment fund in New York. Upon graduation from Cornell, Hamid joined Toll Brothers' Southern California team, and has focused on luxury home building in Orange County and Los Angeles.



Introduction

Real estate is among the most strategic of businesses. Each property class has both independent and linked economic, demographic, and political constituents. Moreover, there are dozens of parties involved that influence the real estate project's final outcome. At every stage of a given project, the participants learn new information that affects their plan. Developers learn about the market, local government actions, and tenant decisions, while tenants learn about consumers and competitors. The nature of the business requires and rewards *flexibility*.

This paper focuses on flexibility and its value in real estate dealings. Specifically, it applies the concept of optionality as considered in corporate finance to address the true value of flexible strategies to real estate practitioners. In recent decades, real estate has evolved in terms of complexity. It has adopted concepts related to valuation from the research-rich field of finance. This trend will logically continue as the real estate industry becomes more efficient and institutionalized.

This paper explores the mechanics of real estate optionality and applies the discussed concepts to practical examples. The types of option agreements covered include the following:

- Option to purchase developable land
- Option to renew a commercial lease
- Option to terminate a commercial lease

Industry examples are used to provide impactful applications of these topics to developers, investors, and tenants. In the first section concerning land options, a seller faces a decision on choosing between two unique offers from independent developers. The optimal choice is determined by recognizing the financial market value of an option embedded in one of the offers.

In the second and third sections of this paper, the renewal and termination options are considered from the eyes of commercial retail tenants and landlords. Unique cases are presented, and the value of each option is demonstrated using advanced, yet applicable, option pricing methods. Additionally, the renewal option is covered with respect to its value dependants, as well as its worth across U.S. markets.

The option contract: An overview

An option agreement is the right, *without obligation*, to obtain something of value upon payment or trading something else of value.¹ The exchange would involve buying or selling an underlying asset at a fixed price within a set period. When the option gives its owner the right to buy an asset it is known as a "call," and when it gives the right to sell, it is a "put." As signified by the names, the option is used or "exercised" when the underlying asset is

¹ David M. Geltner et al., *Commercial Real Estate Analysis and Investments* 730 (2nd ed. 2006).

called in by the call owner, or placed away with another investor by the put owner.² For the call owner, the option would be “in the money” when the specified exercise (or strike) price is lower than the market price of the asset. This difference between the strike and market is referred to as intrinsic value. The call owner will only exercise the option if it is in the money, otherwise the asset can be bought at a lower price in the market. When the call owner exercises the option, the counterparty (call seller) is obligated to sell the asset at the specified price. On the other hand, when the put is exercised, the counterparty (put seller) must buy the asset at the specified price. Option contracts typically have a limited life and must be exercised prior to their expiration or “maturity” date.

Different styles of call and put contracts exist and have been categorized by their inherent terms. The best known are the “European” and the “American” options. The exercise of a European option is permitted only upon expiration, whereas the American option may be exercised at any time prior to expiration. This makes the American option more valuable. Nevertheless, the analysis of European options provides great insight for the valuation of most options in the world.

Similar to traded options on financial securities, real options in real estate are contractual commitments between buyers and sellers of property, or landlords and tenants, allowing option holders to hedge business risks. Among other things, real options provide flexibility and insurance when unanticipated outcomes might unfold. The option holder limits the downside while maintaining exposure to the upside. A more detailed review of real estate options may best be introduced through a discussion of land purchase options.

Land purchase option

When the topic of options is brought up in real estate, it often relates to land. Sophisticated real estate practitioners understand land options and hold it in their acquisitions tool-kit. A land developer may use this option as both a financing tool and a risk-mitigating tool. As a financing tool, the developer preserves cash by purchasing the land in stages. The developer buys a small portion of the land, generates cash from lot-sales and deposits, and reinvests some of the proceeds into purchasing more land in stages. As a risk-mitigating tool, the developer minimizes the downside from diminishing project value, which may be caused by supply and demand factors or unsuccessful building approvals.

At the negotiation table, however, the counterparties commonly guess the value of an option. The buyer empathizes with the seller and offers an amount that will not insult, but will induce the seller to grant the option. Ambitiously so, the buyer may also request that the option fee be applied towards the purchase price. The seller, on the other hand, will do everything to raise the amount paid in exchange for the option. Ultimately, the buyer wants to know when to walk away from the deal to avoid overpaying for the option.

The following industry example will illustrate one way to approximate land option value. The case involves two developers interested in acquiring a high-potential downtown parcel, and a seller who wishes to select the most financially attractive offer.

Land option value in a revitalizing downtown

Cities around the country have focused on redeveloping their urban cores. Initiatives ranging from building vibrant districts and green spaces to re-zonings have affected real estate values in downtowns. Opportunistic investors may seek to capitalize on occasions when infield land or buildings may be purchased in soon-to-be revitalized areas. However, there is substantial risk associated with such strategy. There are great uncertainties about the exact location and impact of economic development initiatives on future property

Author

Sina Lashgari joined Cornell University in 2010 as Irwin D. Jacobs fellow, where he is pursuing his PhD in the School of Electrical and Computer Engineering. His research is focused on mathematical analysis of wireless networks. Since 2010 he has been involved in a joint collaboration with Intel, Cisco, and Verizon on addressing emerging challenges in the next generation of wireless networks. He has published numerous papers in the area of Information Theory, and has a US patent pending on device-to-device communications.



² Gary W. Emery, *Corporate Finance Principles and Practice* 310 (1998)

Author

Duane Stiller has always believed in making Florida's places better. He founded Woolbright in 1985, and from the beginning he established industry knowledge, personal service and innovation as core values for the Woolbright team. Mr. Stiller built Woolbright Development into one of the fastest growing retail real estate companies in Florida, and during the last decade the firm acquired 56 retail projects totaling 8.5 million square feet. Historically, Woolbright's typical projects consisted of redevelopments of existing shopping centers located in Florida's densely populated metro areas. Recently, ground-up developments have been incorporated into the Woolbright project mix, and this successful combination has helped make Woolbright Development one of the largest acquirers, managers and top 10 owners of retail real estate in Florida.



Exhibit A

values. This is when an option on developable land is most valuable.³

Consider a piece of land located in a mid-sized city's downtown. The owner is marketing the for-sale property while city officials make plans to promote downtown. The officials announced at a recent public meeting that numerous development tax-incentives and capital investments are expected over the course of the next year. Also, the city noted proposed re-zonings that would allow for higher real estate uses and densities in some sections of downtown.

After widespread marketing efforts by a well-known brokerage firm, the land seller began formal dialogue with two potential developers that submitted bids during the "call for offers." Their offers were:

Offer-A

- Cash offer of \$1,000,000
- Earnest money deposit of \$15,000
- 25-day due diligence period—\$15,000 deposit is refundable until 5 days before closing
- Closing to be scheduled and held on the 30th day after contract execution

Offer-B

- Cash offer of \$1,050,000
- Earnest money deposit of \$50,000
- 15-day due diligence period — \$50,000 deposit becomes nonrefundable after 15 days
- Closing to be scheduled and held on the 30th day after contract execution
- Buyer may request to extend the date of closing and shall be granted the right to reschedule closing date until up to 365 days after the end of due diligence period.

The offer amounts are close to the brokerage firm's initial estimate. The advisory team had analyzed future prospects for downtown, concluding that one year from now (after the downtown plan is solidified) the land's residual value would either be \$1.25 million or \$800,000. As shown in Exhibit-A, the higher value of \$1.25M is more likely with an expected probability of 60%. If major re-zonings are not initiated near the site, however, the value of the land will decrease to \$800,000, representing the price when there were no talks of downtown revitalization. Therefore, the advisory team had estimated a market value of \$990,741⁴.

Year	0	1
Market value	\$990,741	<i>Probability: 60%</i> \$1,250,000 <i>Probability: 40%</i> \$800,000

Note: Based on a risk neutral valuation (interest rate 8%⁵)

Comparing the offers:

The seller found Offer-B attractive, as he favored receiving more money for the land and the \$50,000 deposit becoming non-refundable after 15 days.

³ Sheridan Titman, Urban Land Prices Under Uncertainty, 75 The American Economic Review (No. 3) 505-514 (1985)

⁴ For simplicity of explanation, taxes and carrying costs have been ignored in this example.

⁵ The risk-free interest rate noted represents a continuously compounded rate for a 1-year maturity treasury bond, which matches the duration of the property value outcomes.

The seller sat down with the advisory team to compare the offers. The team presented the offer terms as follows:

- Offer-A is a straight forward cash offer. Like most transactions, the buyer gets time to verify the characteristics of property. In this case, the buyer has asked for a 25-day due diligence period, meaning it can back-out up to 5 days before closing. The buyer’s deposit shall only be returned if material defects, such as environmental issues, are found.
- Offer-B is more interesting. The due diligence period is shorter and the earnest money deposit is higher than what is proposed in Offer-A. Both these points illustrate a higher level of commitment from offer-B. Additionally, the offer amount is \$50,000 greater than offer-A.

Notwithstanding the customary closing date, the buyer has requested an extension right up to 365 days for closing. Through this, the buyer has offered to purchase an American call option on the property, which grants the right, but not the obligation to purchase the property up to 365 days after the due diligence period. Note that although the proposal does not mention an option anywhere, it cleverly possesses all the characteristics of a call option.

Below are the terms of the call option from Offer-B:

- Strike price: \$1,000,000 (\$1,050,000 purchase price - \$50,000 nonrefundable deposit)
- Price offered for option: \$50,000
- Option maturity: 1 year (365 days)

Offer-B's option value calculation:

The advisory team evaluated the option embedded in Offer-B by applying corporate finance techniques to an intrinsically similar real estate problem; namely, the “binomial” option pricing and the “replicating portfolio” theories.⁶

Within one year the property’s value is expected to be either \$1,250,000 or \$800,000, depending on the city official’s rezoning decision. The option in Offer-B will be worth either \$250,000 or \$0 depending on the outcome of the city’s rezoning decision. Since this one major event – the rezoning – affects the option’s value, a single-period binomial model is used. The binomial trees in Exhibit-B show the outcomes.

The value of the call option is determined by finding a portfolio that replicates the

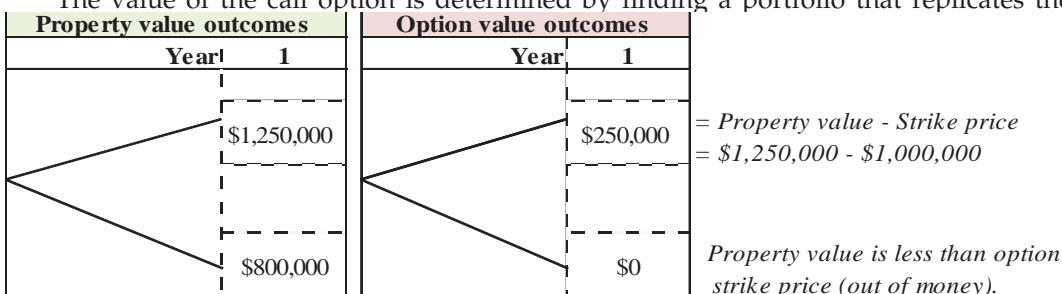

option’s payoff in both states of nature. The replicating portfolio will look as follows:

A long position in the underlying asset: owning the property (or a portion of it)

A short position in the risk-free bond

⁶ John C. Cox et al., Option Pricing a Simplified Approach, 7 Journal of Financial Economic (Issue 3) 229-263 (1979), available at http://fisher.osu.edu/~fellingham_1/seminar/CRR79.pdf.

“...although the proposal does not mention an option anywhere, it cleverly possesses all the characteristics.”

“The replicating portfolio theory puts aside arbitrage opportunities and allows for a proper option valuation.”

Exhibit B



A portfolio with the appropriate composition of the above positions will generate the same cash flows as the call option and thus should have the same value. The replicating portfolio theory puts aside arbitrage opportunities and allows for a proper option valuation. Hence, the cost of the replicating portfolio will be the fair value of the option. The following equation illustrates this point:

$$C_o = N_s * V_s + N_b * V_b$$

Where:

C_o is the call option value

N_s is the number representing the position in the underlying asset (the property)

V_s is the value of the underlying asset (the property)

N_b is the number representing the position in the risk-free bond

V_b is the value of the risk-free bond

This translates to: *Call option = Positions in the underlying asset + Position in risk-free bond*

The values of the assets (property, risk-free bond⁷, and option) at different states are presented in Exhibit-C.

Exhibit C

Up-state: $V_s = \$1,250,000$		Down-state: $V_s = \$800,000$			
Property value outcomes		Bond value outcomes		Option value outcomes	
Yr. 0	Yr. 1	Yr. 0	Yr. 1	Yr. 0	Yr. 1
	\$1,250,000		\$1,080		\$250,000
\$990,741		\$1,000		?	
	\$800,000		\$1,080		\$0

$V_{bup} = \$1,080$
 $C_{Oup} = \$250,000$

$V_{bdown} = \$1,080$
 $C_{Odown} = \$0$

These values will be input into the replicating portfolio equation to solve for the appropriate asset composition.⁸ Accordingly, the option value of Offer-B is solved.⁹

$$\text{Land option value} = \$138,956$$

The option embedded in Offer-B provides the developer with insurance against the downside and exposure to the upside – a package worth precisely \$138,956. Hence, the developer’s \$50,000 deposit offered as option premium is not commensurate to the flexibility gained from the contract.

Commercial lease options

“Renewal” and “Termination” clauses are frequently used commercial real estate lease options that are substantially important to their counterparties. In the industry, the economic value of lease options is significant to tenants, investors, and the financial

⁷ The risk-free bond’s payoff is independent of the property and the option’s payoffs. At year-1, a \$1,000 zero-coupon bond with a yield of 8% and one-year maturity will be worth \$1,080 in both states.

⁸ Up-state: $\$250,000 = N_s * \$1,250,000 + N_b * \$1,080$
 Down-state: $\$0 = N_s * \$800,000 + N_b * \$1,080$
 $N_s = 0.5556$
 $N_b = -411.5$

⁹ $CO = N_s * \$990,741 + N_b * \$1,000$
 $CO = \$138,956$

markets. Despite this, the real value of lease options is an unknown “black box.” This is partially because many intricate details affect the value of lease options. Examples of this are moving expenses, location goodwill value, monopoly strategies, and build-out costs. These transaction-specific issues cannot easily be integrated into option pricing models, making lease option valuation difficult. However, as explained in the following section, there are certain lease option attributes that can be characterized and priced using option valuation methods.

Renewal option: The tenant’s upside

A “renewal” option gives a tenant the right to renew its lease upon expiration. Depending on the agreement, it generally allows the tenant to extend its lease at either a specified rental rate, at the original rate grown based on an index, or at a percent of market. This contractual right allows the tenant to mitigate the risk of substantial future rent increases imposed by the landlord, especially if the tenant does well at the location. Arguably the main reason behind a renewal option, the limit on rent increases is intended to ensure fair dealings and does not necessarily possess optionality value.

Without regard to the initial intention, however, there is built-in upside in renewal options that may be captured by tenants. In a lease with a specified renewal rate, the upside is the difference between the renewal rate and the going market rate for the space upon renewal.¹⁰ For example, a tenant may sign a ten-year lease today for \$10.00 per square foot (psf) and obtain an option to renew the lease at a fixed rate of \$12.50 psf in ten years. If at the time of renewal, market rental rates for comparable space had risen to \$13.50 psf, then the tenant would capitalize on a \$1.00 psf annual value for the entire second term by exercising the option.

The upside characteristic in the example above is similar to that of a call option on a common stock. Hence, the benefit to tenant from this potential upside, or the cost to landlord, may be estimated using basic option pricing models developed in the field of finance.¹¹ This point is demonstrated in the following example of a lease with a renewal option.

Florida anchor retail tenant

The excerpt that follows is from a lease contract pertaining to a national retail anchor tenant. The real estate – a community shopping center – is located in the Palm Beach, Florida metro area. Specific information about lease counterparties and terms has been removed to protect the confidentiality of the contract.

“If, at the end of the Initial Term of this Lease, this Lease shall be in full force and effect and Tenant is not in material default of any of the terms, conditions or covenants of this Lease beyond the provisions for notice and cure, Tenant is hereby granted two (2) individual consecutive options to extend the term of this Lease (the “Renewal Term(s)”) for additional terms of sixty (60) months each upon the same terms and conditions contained in this Lease, except for (a) Base Rent which shall be fixed at (i) Seventeen 50/100 Dollars (\$17.50) per square foot for the first Renewal Term, and (ii) Eighteen and 50/100 Dollars (\$18.50) for the second Renewal Term, as applicable, and (b) Landlord shall not be required to provide any rent free periods, rental concessions, inducements, allowances or similar items, nor shall Landlord have any construction obligations relating to the Premises (Tenant agreeing to accept the Premises in their condition as of the commencement of each such Renewal Term). Failure of Tenant to exercise the first option for a Renewal Term shall also

¹⁰ In other common renewal agreements where the renewal rate is based on the prevailing market rate, the option’s value would be dependent on minimizing tenant moving costs (business disruption, loss of goodwill) and other expenses.

¹¹ A renewal option valuation that captures all related business and lease contract details may not be conducted by any single derivative pricing method, while the upside to tenant in an option agreement with a fixed renewal rate can be.

terminate all subsequent Renewal Terms.”

The tenant has obtained two consecutive 5-year renewal options at the fixed rates of \$17.50 psf and \$18.50 psf. The length of the current lease is five years and at a rate of \$16.50 psf. The tenant may exercise its first option before the expiration of the current lease.

Many details of the lease and tenant strategies behind renewal options cannot be incorporated into an option pricing model. However, as explained before, the potential upside to the tenant from higher market rents can be valued this way. The payoff from the difference of the market rate and the option renewal rate behaves more like a “call” option. Therefore, an option pricing model such as the Black–Scholes¹² may be used to estimate the value of this benefit to tenant.

Renewal terms from the example lease contract translate to the following call option characteristics:

- First option:
 - Strike price: \$17.50 psf
 - Option maturity: 5 years
- Second option:
 - Strike price: \$18.50 psf
 - Option maturity: 5 years
 - Vesting term: Upon renewal of the first option

This case covers only the value of the first option, although through appropriate adjustments the results are also extendable to the second option.

Market inputs: Palm Beach, FL

The following variables are used in the option pricing equation to forecast future lease rates.

- Current rate: The market rate and the initial lease rate for the space is currently \$16.50 psf. The current state of the market is used to project the “path” or likely future states of the market. The path will lead us to where lease rates might be five years from now, when it is time to renew the lease. This is important as we consider the outlook for the option being “in the money.”
- Market volatility:¹³ In just a few words, market volatility tells us how considerable lease rate movements (growths and declines) have been in the past. This gives a taste of “market behavior,” which has to do with the question: *by how much might the market go up or down in the future?*
- Market rate of growth: Also based on the past, the market rate of growth augments the previous variables in coming at the probable future states of the market.

Option ingredients:

The value of the upside from the option to tenant, or the cost to landlord, is found by determining the characteristics of the call option.

- Renewal rate (strike price): If the first renewal option is exercised, the tenant pays the fixed amount of \$17.50 psf every year during the second term.
- Option maturity: The first renewal may be exercised before the expiration of

¹² Fischer Black and Myron Scholes, The Pricing of Options and Corporate Liabilities, 81 Journal of Political Economy (No. 3) 637-654 (1973), available at <http://www.jstor.org/stable/1831029>.

¹³ REIS, REIS Metro Market Report (2012), available at <https://www.reis.com/market-reports-single-metro-apartment/florida/palm-beach> (historical effective rents since 1990 were gathered using REIS Metro Market Report, and used to derive volatility and growth for the market lease rates).

current lease (within 5 years).

- Risk-free interest rate: Another important variable used in the option pricing calculation is the risk-free rate of interest, assumed to be 0.77%¹⁴ for this problem. This is the prevailing (January 9, 2013) yield for the 5-year US Treasury, which matches the five year life of the option.

The first option's rental payoff to the tenant is the difference between the market rental rate for the space at the end of the lease (year-five), and the fixed renewal rate of \$17.50 psf.¹⁵

With the option characteristics identified, this renewal option is valued as a *European call option*, using the Black-Scholes model. It is worth noting that since the renewal may be exercised at any time during the five year period, it is comparable to an "American" type option. However, the tenant's rational decision is to keep the option as insurance for as long as possible. Thus, it should exercise the option only at expiration, making the value equivalent to a "European" option.¹⁶ The "European" model is further justified as the payoff to the tenant is dependent on the rental worth of the space at the end of the lease, which matches option expiration. For these reasons, the option may be priced as a "European" type option.

The solution is as follows, and calculations are provided at the end of paper:

$$\text{Renewal option value} = \$1.26 \text{ per square foot}$$

Renewal option values across U.S. markets

Considering the market inputs from the previous Florida-based case, one can imagine how the upside in renewal options might differ geographically. Exhibit-D is an option valuation map that illustrates the worth of renewal options¹⁷ in a handful U.S. markets¹⁸. Similar to the previous case, the represented underlying assets are neighborhood and community shopping centers, including strip centers between 10,000 and 350,000 square foot. Most importantly, the option renewal rates are based on current effective rents, grown for five years at the historic growth rates for each market.

In support of the valuation map above, an illustration of the option's directional value is provided to visualize its sensitivity to important variables.

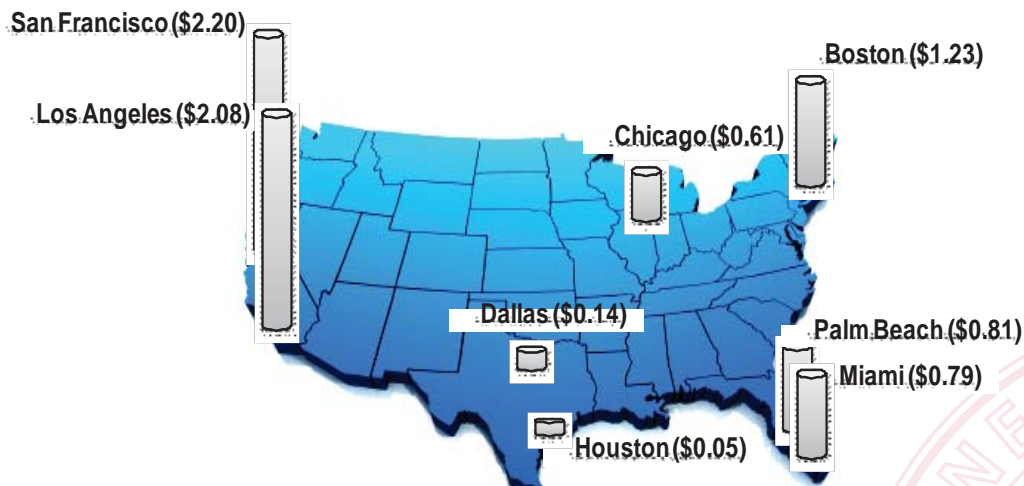

Exhibit-E shows the impact of market volatility and current lease rate on the potential

¹⁴ Bloomberg, United States Government Bonds, Bloomberg, April 15, 2013, <http://www.bloomberg.com/markets/rates-bonds/government-bonds/us/>.

¹⁵ The tenant only considers the market rental rate upon lease expiration as it does not intend to pause its business operations to lease at a later point.

¹⁶ Robert C. Merton, Theory of rational option pricing, 4 The Bell Journal of Economic and Management Science (Issue 1) 141-183 (1973).

¹⁷ Option durations are 5 years, and the risk-free (5-year US Treasury, January 9, 2013) yield is 0.77%.

¹⁸ Values for some major markets including New York are not included in the figure due to the insufficiency of the target asset (neighborhood/community shopping centers) within those markets.

Exhibit D

Values represent \$ per square foot.

payoff (renewal option value) to the tenant.¹⁹ A market such as San Francisco experiences both variable of high market rates and historical volatility, thus providing the highest value to the option holder.

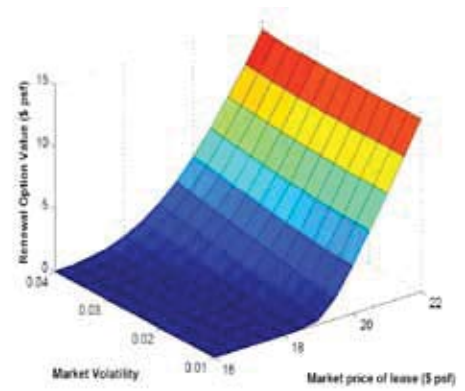

Termination clause: An option to abandon

A termination clause in a lease is a valuable option to the tenant. This is especially true for retail tenants as their profits often rely heavily on the early success of a project. If a project or even a particular store in a chain gets off to a bad start, its chances for ultimate success can be low.²⁰ A retail tenant may exercise a termination option when the expected present value of store cash flows (excluding payment for lease) is less than the present value of the lease itself. That is, when the tenant learns it will not have sufficient cash flows at the location to satisfy lease obligation and the required return for the business, it will discontinue the operation and terminate the lease. The following example demonstrates the value of a two-year termination clause to a retailer, again using the binomial option pricing methodology.

A flexible lease: The worth to a retailer

Harold’s, an established boutique outfitter, is looking to add a store in a new market. It projects operating metrics ten years into the future and estimates cash flow variability based on previous store openings (projections up to year-2 are shown in Exhibit-F). Harold’s understands the risk inherent in new store investments and the chances of failure. Considering that the first few years are crucial in determining how well the location will do in the long term, the real estate managers of Harold’s always secure a “termination clause” in their store lease. A termination clause in a lease contract acts like an “abandonment option.” It limits business downside, as it allows Harold’s to get out of its lease obligation should it learn the store is not profitable.

As Harold’s gets further along in its search for space in the new market, it learns that some landlords are open to the idea of a termination clause. However, based on conversations with brokers, termination clauses are not common for small tenants and, if given, might mean that the landlord will be less willing to agree to tenant concessions; the common market concession for the type of space Harold’s was looking for was 6-months

(in '000s)

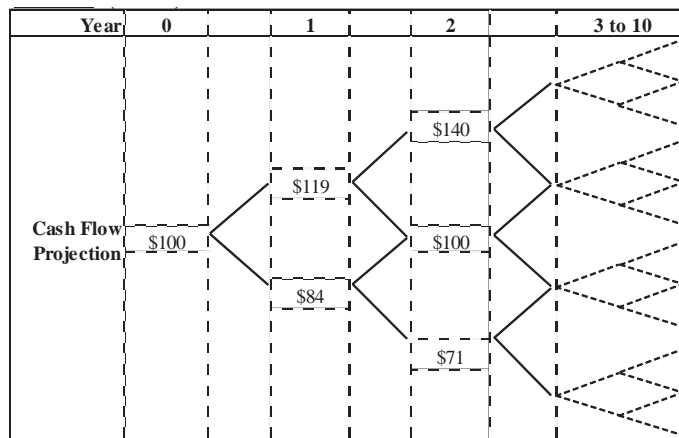

¹⁹ Exhibit variables include a 5-year maturity option with a fixed renewal rate of \$20 psf.

²⁰ Scott E. Burk, Esq. & Mario J. Suarez, Esq., Thompson Hine LLP, Green Retail: Gaining Momentum (2009), available at <http://www.thompsonhine.com/publications/pdf/2009/02/greenretailgaining1707.pdf>.

free-rent. The decision would be simple once the value of the option is determined. A binomial model is once again used to illustrate the valuation process.

Option Ingredients:

The value of the abandonment option can be estimated by determining the characteristics of the *European put option*.

- **Business risk (variability of cash flows):** A simulation of cash flows from Harold's previous new store investments yields a variance of 0.03 in the present value of cash flows. Variance, a simple statistical calculation, illustrates how variable cash flows have been in the past. This historical figure helps predict likely future paths for cash flow, as illustrated by the binomial trees.
- **Termination option strike price:** If the store was unsuccessful and Harold's were to terminate the lease, it would mitigate losses by the amount of the remaining value of the lease. The total annual rent Harold's expects to pay is \$69,600. With a lease length of ten years, the present value of the remaining lease in each period is shown in Exhibit-G. Note that lease payments are predictable in nature and shall be discounted at the risk-free rate.²¹
- **Value of the business (underlying asset):** Given a termination clause that expires in two years, Exhibit-H shows Harold's value until the second year. The business

Year	0	1	2
Lease Value at Year End (in '000s)	\$564,518	\$517,499	\$468,599

Exhibit G

value is simply the present value of the store's future cash flows, discounted at the appropriate rate for the project (8.8% in this case).²² At the beginning, Harold's projects \$100,000 annual cash flows (Exhibit-F) for the life of the project, so its present value is \$647,000 (Exhibit-H). After the first year, Harold's learns more about the location's potential. It either generates \$119,000 in the up-state, or only \$84,000 in the down-state. Hence, the value of the business is adjusted accordingly.

- **Life of termination clause (time to maturity):** The termination clause will expire at the end of the second year. Hence, the option has two years until maturity.

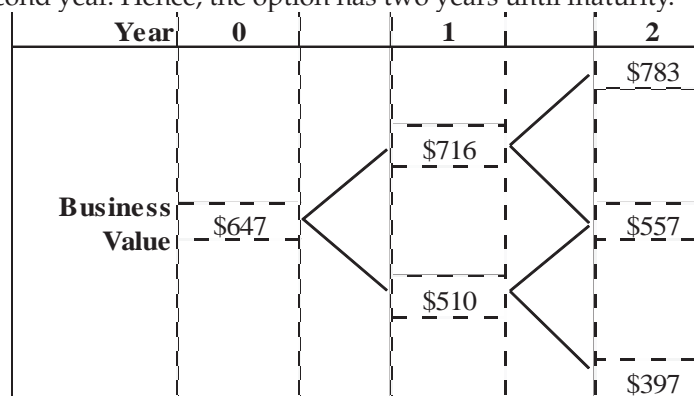

Exhibit H

(in '000s)

- **Risk-free rate:** The yield for the 2-year U.S Treasury²³, which matches the two year life of the option, is used in the risk neutral discounting of option payoffs.

Accordingly, the option is valued by:

²¹ Interview with Andrey Ukhov, Cornell University, Ithaca, NY (February 4th, 2013).

²² The appropriate risk-adjusted discount rate for a given project may be derived by using the historic Beta of previous stores (the correlated volatility of the underlying business to the financial market, the S&P 500) and the Capital Asset Pricing Model (CAPM).

²³ A risk-free rate of 4% is used in this case.

Determining the potential payoffs at maturity (demonstrated in Exhibit-I)
 Calculating the option's value in each prior period through a risk-neutral valuation²⁴.

With the above calculation, Harold's can make a decision about whether it's worth giving up the rent concession (6-months of free-rent) in exchange for the termination

Exhibit I

(in '000s)

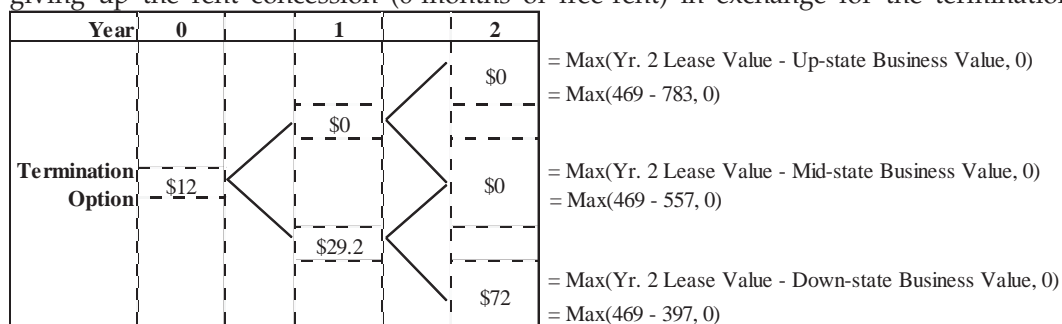

clause. The present value of half of the year's rent to Harold's is \$34,398, while the option is worth \$11,858. Therefore, in this case a termination clause is worth giving up in exchange for the months of free-rent. If the unpredictability of Harold's cash flow were much higher, however, the option would certainly be worth more, as it would hedge against greater business downside.

Conclusion

Real estate decision makers develop business plans and lay out their strategy when they initiate a new project. As they move along and are faced with the world's realities, however, they consider new opportunities and revise their strategy. Developers, investors, and tenants of property make decisions based on the information they learn at each step, and so must consider the built-in flexibility of their plan when estimating its value.

Flexibility in real estate transactions, or the option to proceed or not proceed with a contractual agreement, is inherently similar to options on financial securities. Real estate option contracts may be evaluated through simplified option valuation approaches that are commonly utilized in corporate finance. In the cyclical business of real estate, practitioners who have an understanding of optionality may apply their knowledge to their favor and mitigate business risk while maintaining exposure to business upside.

Acknowledgements

This paper was influenced by many, including organizations and individuals whom I would like to acknowledge. I would first like to thank Dr. Andry Ukhov, my professor who spent the better half of his course (Advanced Corporate Finance, taught at the Cornell Hotel School) looking at the world through options. On the first and last day of the course he said, "business people that get the concept of optionality will save their own time and other people's money." I would also like to thank professors Walter Boudry and John "Jack" Corgel for sharing their advice with me on the topic of the paper.

In addition to my professors, I am grateful to the Cornell Real Estate Review and the Baker Program in Real Estate for granting me the opportunity to write this paper. This opportunity truly enriched my educational experience by allowing me to dig deeper into my course-work interests. From the Real Estate Review team, my colleague and friend Jason Patch provided outstanding guidance on the overall paper.

²⁴ As discussed in the first section (Land Purchase Option), risk-neutral valuation involves multiplying expected future value outcomes by their respective probability of occurrence, where the implied probability of outcomes is determined based on historical variance of business cash flows.

A few other individuals have and continually inspire me during my endeavors at school and beyond. Among those, I owe a great deal to Dr. Gary Emery, my former professor at the University of Oklahoma. Through his remarkable Entrepreneurial Finance course and home-works that required burning the midnight oil, he instilled in me an appreciation and intuition for business finance. Additionally, my mentors and friends Dr. Lowell Busenitz and Dr. Evgenia Golubeva from the University of Oklahoma have greatly contributed to my passion and dedication to this paper and beyond. Finally, I thank my brother, parents, and grandparents who are at the core of everything I do and are always there for me.

Appendix

Calculation - Lease renewal option: Florida anchor retail tenant

The behavior of market lease rates is modeled by a Geometric Brownian Motion (GBM)²⁵ with market rate of growth of μ and volatility σ . A GBM is a continuous-time random process, in which the logarithm of the randomly varying quantity follows a Brownian Motion. The following formula represents the path of the lease market rental rates.

The market rate of lease is denoted by $S(t)$, where $0 \leq t \leq 10$.

The Brownian Motion formula, which models the behavior of the market, is denoted by $W(t)$.

The risk-free interest rate is denoted by r .

The fair value of the renewal option is denoted by V .

The payoff of the renewal option is denoted by P . Note that payoff of the option at year 5 is stochastic, or non-deterministic, and depends on how the market price of lease evolves during year 5 to year 10.

The following formula represents the potential payoff from rental upside at year 5:

The market rate of lease at the end of year five is denoted by S_5 .

The fixed contract renewal rate is denoted by K .

The lease option, priced as a European call option in the Black-Scholes model is fairly priced as such:

where

and $N(d)$ is the cumulative standard normal distribution function
 $d = 1.26$

²⁵ STEVEN E. SHREVE, STOCHASTIC CALCULUS FOR FINANCE II CONTINUOUS-TIME MODELS 106 (2nd ed. 2004).