

Historical Mechanisms for Drawing Curves

Daina Taimina, Cornell University

(Supported by National Science Foundation grant DUE-0226238)

Some Early Mechanisms

If you have a collection of straight sticks which are pinned (hinged) to one another at their ends, then you can say you have a linkage like the one in our car as windshield wipers or on our desk as some desk lamps. Linkages can also be robot arms. It is possible that because of similarity with our own arm people started to think about the use of linkages. We can find linkages in drawing curves in ancient Greece. Mechanical devices in ancient Greece for constructing different curves were invented mainly to solve three famous problems: doubling the cube, squaring the circle and trisecting the angle. There can be found references that Menechmus (~380~320 B.C.) had a mechanical device to construct conics which he used to solve problem of doubling the cube. One method to solve problems of trisecting an angle and squaring the circle was to use quadratrix of Hippias (~460~400 B.C) – this is the first example of a curve that is defined by means of motion and can not be constructed using only a straightedge and a compass. Proclus (418-485) also mentions some Isidorus from Miletus who had an instrument for drawing a parabola. [Dyck, p.58]. We can not say that those mechanical devices consisted purely of linkages, but it is important to understand that Greek geometers were looking for and finding solutions to geometrical problems by mechanical means. These solutions mostly were needed for practical purposes. This was in spite of the fact that in theoretical Euclidean geometry there existed demands for pure geometrical constructions using only “divine instruments” -- compass and straightedge.

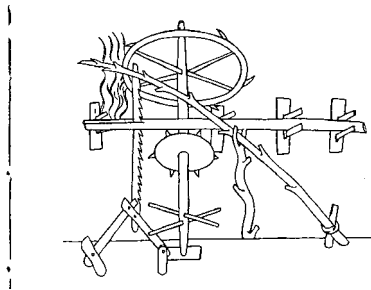

Figure 1. Sawmill from [Honnecourt]

We can find use of linkages in old drawings of various machines in 13th century like in Figure 1.

Another source for use of machines in 16th century are works of Georgius Agricola (1494-1555) who is considered a founder of geology as a discipline. Agricola's geological writings reflect an immense amount of study and first-hand observation, not just of rocks and minerals, but of every aspect of mining technology and practice of the time.

I have omitted all those things, which I have not myself seen, or have not read or heard of from persons upon whom I can rely. That which I have neither seen, nor carefully considered after reading or hearing of, I have not written about. The same rule must be understood with regard to all my instruction, whether I enjoin things, which ought to be done, or describe things, which are usual, or condemn things, which are done. (Agricola in preface to *De Re Metallica*, 1556)

In the drawings that accompanied Agricola's work we can see linkages that was widely used for converting the continuous rotation of a water wheel into a reciprocating motion suited to piston

pumps. [Agricola] In a past linkages could be of magnificent proportions. Linkages were used not only to transform motion but also were used for the transmission of power. Gigantic linkages, principally for mine pumping operations, connected water wheels at the riverbank to pumps high up on the hillside. One such installation (1713) in Germany was 3 km long. Such linkages consisted in the main of what we call four-bar linkages, and terminated in a slider-crank mechanism. In Figure 2 we can see use of a linkage in a 16th century sawmill.

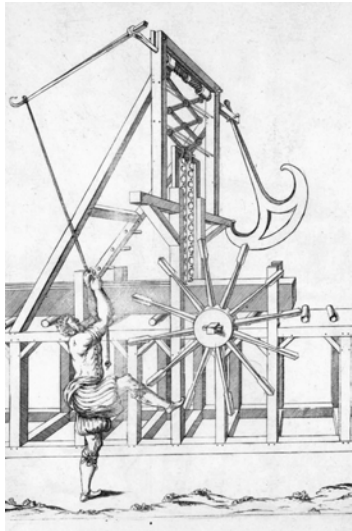

Figure 2. Sawmill from [Besson]

Early Curve Drawing

Leonardo da Vinci (1452-1519) invented a lathe for turning parts of elliptic section, using a four link mechanism, an ellipsograph with an inverted motion of the fixed link. Mechanical devices for drawing curves were used also by Albrecht Dürer (1471-1528). See two pictures from his “Four books on proportions” in Figure 3.

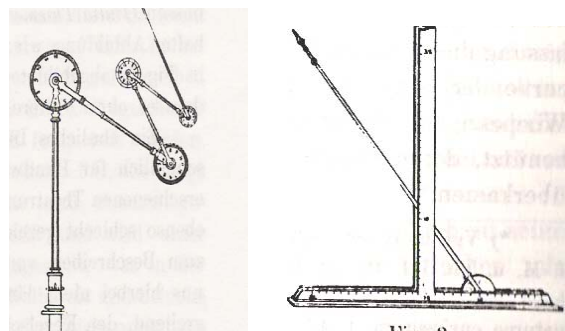

Figure 3. Curve drawing devices from [Dürer]

When Rene Descartes (1596-1650) published his *Geometry* (1637) he did not create a curve by plotting points from an equation. There were always first given geometrical methods for drawing each curve with some apparatus, and often these apparatus were linkages. See Figure 4.

La Hire's proof of this theorem was based on the theory of rolling curves or centrodes. But this result was proved already before La Hire. In Proclus we can find the following:

Nor yet if you suppose a right line moving in a right angle, and by intention to describe a circle, is the circular line, on this account, produced with mixture? For the extremities of that which is moved, after this manner, since they are equally moved, will describe a straight line and the centre, since it is equally developed, will describe a circle, but other points will describe an ellipse. [Proclus, p.130]

There is another theorem that has been rediscovered many times, but the priority seems to go to Nasir al-Din al-Tusi (1201-1274). Al-Tusi made the most significant development of Ptolemy's model of the planetary system up to the development of the heliocentric model in the time of Copernicus (1473-1543). The theorem that was also referred to in Copernicus concerns the famous "Tusi-couple" which resolves linear motion into the sum of two circular motions. The Tusi couple is obtained by rolling a circle of radius a inside a circle of radius $2a$. See Figure 6 and 7. The result is a line segment equal to the radius of the largest circle. Mathematicians sometimes call this a *2-cusped hypocycloid*, but engineers refer to such motion as special cases of planetary gears. See [mathworld] and [dduke]. This idea was also used by F.Reuleaux (1829-1905) as it can be seen in Figure 7.

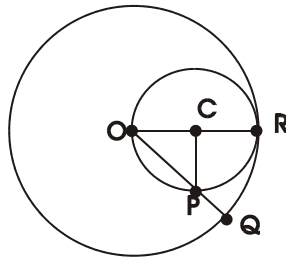

Figure 6. Tusi-couple

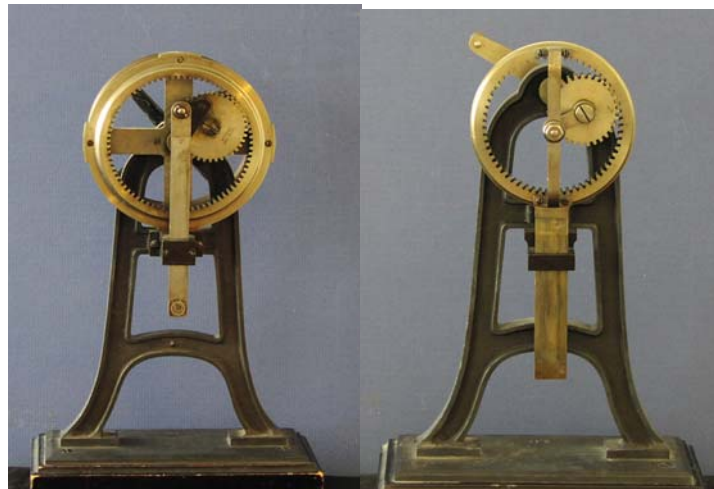

Figure 7. Tusi-couples from Reuleaux models (photo Prof. F. C. Moon)

In Figure 6, $OR = 2 CR$, $\angle PCR = 2\angle POC$, thus arc $PR =$ arc QR and point P in this picture is describing a straight line but point C moves on circle. The fact that C traces a circle suggests a mechanical improvement to make this Tusi couple into ellipsograph. Suppose that we have a thin rod of fixed length, one of whose ends moves on a fixed line, while its other end traces a circle whose centre is on the line while its radius is equal to the length of the rod, a point rigidly

attached to the rod will trace an ellipse. This was described in [van Schooten] who showed how to realize it mechanically (see Figure 10 below).

Trammel for Drawing Ellipses

The most systematic and complete discussion of the treatment of the conics is found in the *Elementa Curvarum Linearum*, of Johan de Witt, which appeared as an appendix to van Schooten's second Latin edition of Descartes *Geometrie*, 1659-1661. [Easton]. Johan de Witt (1625-1672) was a Dutch statesman with considerable skill as a mathematician. While studying law at the University of Leiden he became friends with Francis van Schooten the younger (1615-1660) and received from him an excellent training in Cartesian mathematics. Van Schooten was the main popularizer of R. Descartes *Geometrie* in Europe. According to van Schooten, de Witt's treatise was written some ten years prior its publication.

De Witt describes two more constructions of an ellipse. One of them is the trammel construction, which was described by Proclus but is also attributed to Archimedes (287-212 B.C.). This construction with pictures from Reuleaux kinematic model collection is described in F. Moon's tutorial "How to draw an ellipse" [Moon]. See Figure 8.



Figure 8. Trammel from Reuleaux kinematic model collection (photo Prof. D. W. Henderson)

Here is De Witt's proof why the trammel describes an ellipse.

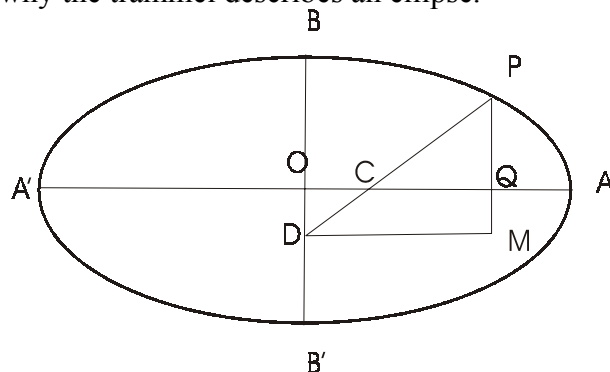

Figure 9. DeWitt's proof of the trammel

Given two perpendicular lines AA' and BB' intersecting at O . In a trammel segment CD moves in a way that C is always on AA' but D is always on BB' . Then if choose a fixed point P on CD (or extension of this segment), point P describes an ellipse with axis AA' and BB' . When C is at

O, then P is in B, and when D is in O, P is in A, thus defining semiminor and semimajor axis of the ellipse. Let us draw $PM \perp OA$ and $DM \perp PM$. Then $PQ/PM = PC/PD$ (from similar triangles). But $PC = OB = OB'$ and $PD = OA = OA'$, so $PQ^2/PM^2 = OB^2/OA^2$. But $PM^2 = OA^2 - OQ^2 = (OA - OQ)(OA + OQ) = AQ \cdot A'Q$, and from here $PQ^2 = (OB^2/OA^2)(AQ \cdot A'Q)$, which is the equation of ellipse if in modern notation we denote AA' and BB' as x and y axes: $y^2 = b^2(a^2 - x^2)/a^2$ or $x^2/a^2 + y^2/b^2 = 1$. Leonardo da Vinci suggested using this trammel construction also in a case when axes are not perpendicular.

Drawing Hyperbolas and Parabolas with Links and Sliders

De Witt suggested also mechanical construction of hyperbola in terms of a rotating line and a sliding segment.

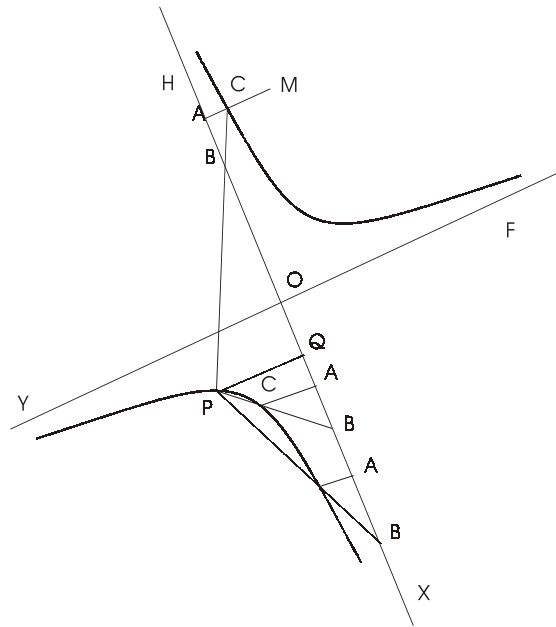

Figure 10. Mechanical construction of hyperbola

Let a line PB rotate about a fixed point P within a two fixed lines HO and FO , intersecting HO at B . When PB is parallel to the other side of the angle, B falls at Q and AB is chosen equal to OQ wherever B falls. At A draw a line AM parallel to OF . The intersection C of AM and PB will be a point on the hyperbola. Triangles PQB and CAB are similar, thus $CA/AB = PQ/QB = PQ/OA$. Since $OQ=AB$, $CA \cdot OA = PQ \cdot OQ = k^2$. [Easton]

In Figures 11, 12, 13 we can see some well-known linkages with slider inside for mechanically constructing conics [van Schooten]

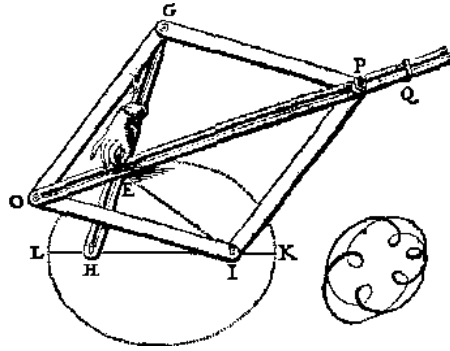

Figure 11. van Schooten mechanism for constructing ellipse

To see this instrument in action and why it works, go to: <http://www15.addr.com/~dscher/vellipse.html>

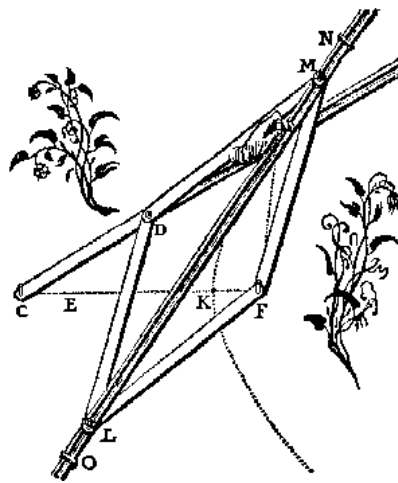

Figure 12. van Schooten mechanism for constructing hyperbola

To see this mechanism in action and why it works, go to: <http://www15.addr.com/~dscher/vhyp.html>

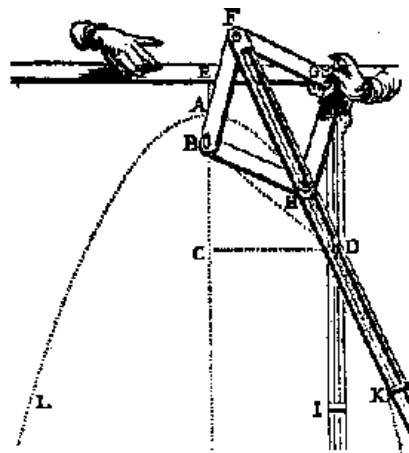

Figure 13. van Schooten mechanism for constructing parabola

To see this mechanism in action and why it works, go to: <http://www15.addr.com/~dscher/schooten.html>

Linkages That Draw Conic Sections

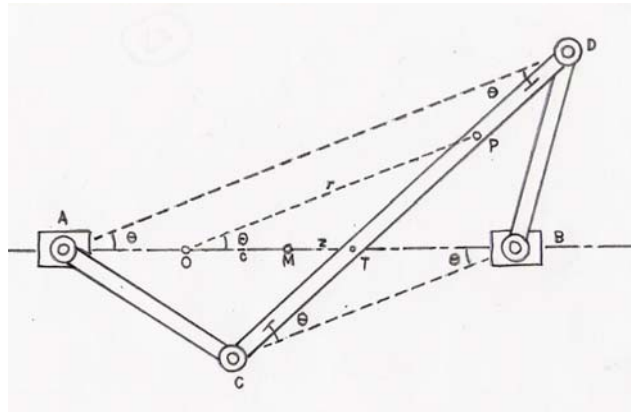

Figure 14. Hart's crossed parallelogram [Yates]

The Hart crossed parallelogram in Figure 14 (with one bar AB attached to the plane), is a trapezoid. Consider a trapezoid ABCD in Figure 14. By examining this trapezoid, the interested reader can verify that as the linkage moves, the product of the variable distances AD and BC remains constant and equal to the difference of the squares of the lengths of radial arms (AC and BD) and traversing bar (CD).

We select a fixed point P on the traversing bar and draw the line OP parallel to AD and BC. It is clear that OP remains parallel to these lines and O is thus a fixed point of the line AB. Let $AC = BD = 2b$; $AB = CD = 2a$, where $a > b$. Let $OP = r$; $OM = c$, where M is the midpoint of AB and $\angle POB = \theta$. Then from the Figure 14:

$$r = 2(c+z) \cos \theta; \quad BC = 2(BT) \cos \theta = 2(a-z) \cos \theta;$$

$$AD = 2(AT) \cos \theta = 2(a+z) \cos \theta;$$

$$(BC)(AD) = 4(a^2 - z^2) \cos^2 \theta = 4(a^2 - b^2).$$

Combining this result with the first equation to eliminate z, we have

$$a^2 \cos^2 \theta - (r/2 - c \cos \theta)^2 = a^2 - b^2.$$

This is the polar equation of the path of P. The quantity c is determined, of course, as soon as the point P is selected.

If we invert this curve, taking O as the center of inversion, so that the transformation is $rs = 2k^2$, we obtain

$$a^2 s^2 \cos^2 \theta - (k^2 - c s \cos \theta)^2 = s^2 (a^2 - b^2).$$

This inverted curve is a conic section, which may more easily be recognized by transferring to rectangular coordinates, using

$$s \cos \theta = x, \quad s \sin \theta = y, \quad s = x^2 + y^2.$$

Thus, we have

$$(c^2 - b^2)x^2 + (a^2 - b^2)y^2 - 2c k^2 x + k^4 = 0.$$

Now, since $a > b$, the coefficient of y^2 is positive and the character of the conic is determined entirely by the coefficient of x^2 . Thus the curve is a parabola, if $c = b$, an ellipse, if $c > b$ and an hyperbola, if $c < b$. In Figures 15-17 we have arbitrarily taken $a = 2b$. The point P' traces the conic.

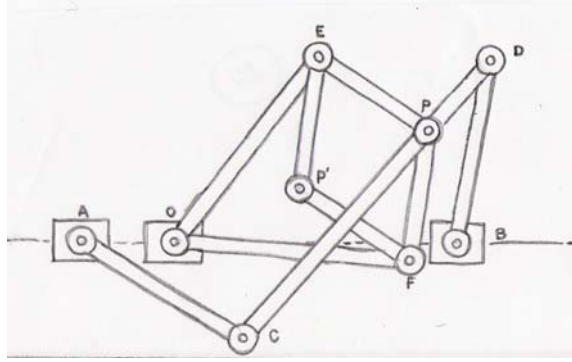

Figure 15. Linkage that draws a parabola [Yates]

Figure 15 shows the linkage for a parabola with $a = 2b = 2c$. Thus, $PD = AO = b$. The point P is inverted to P' by means of Peaucellier cell where $(OE)^2 - (PE)^2 = 2k^2$. For a description of the Peaucellier cell and its properties, see [Kempe].

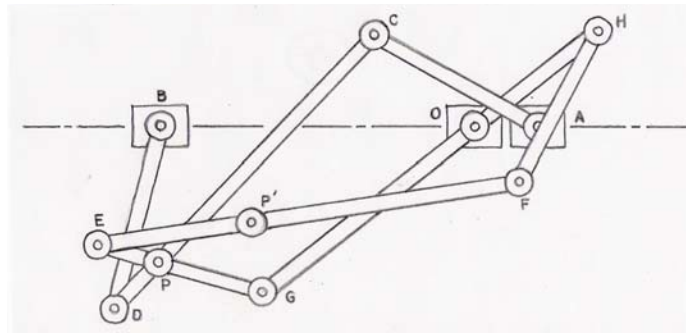

Figure 16. Linkage that draws an ellipse [Yates]

In Figure 16, the linkage is arranged for an ellipse, where $2a = 4b = 3c$. For the sake of variety, P is inverted to P' by the Hart cell $EFGH$. For a description of the Hart cell and its inversive properties, see [Kempe].

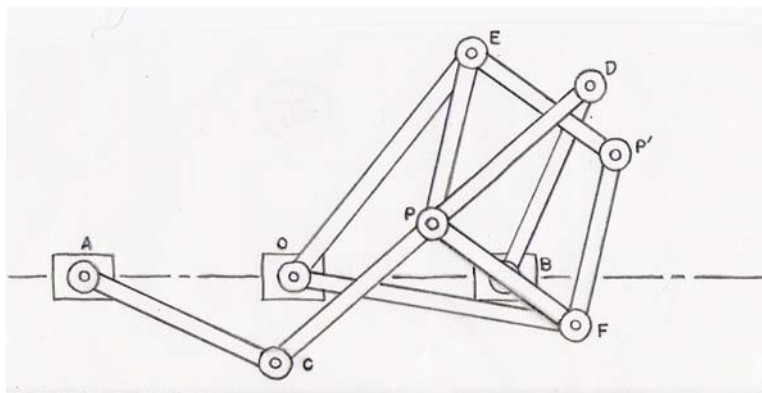

Figure 17. Linkage that draws a hyperbola [Yates]

Figure 17 gives the arrangement for a hyperbola where $a = 2b$, $c = 0$. (P is midpoint of CD .)

Drawing Higher Order Curves

Examining the theory of algebraic curves of the third degree, Isaac Newton (1643-1727) proposed a mechanism for the generation of circular unicursive curves of third degree, using a four-link chain with two sliding pairs. In Figure 18, see realization of this idea in Boguslavskii's conicograph [Artobolevski] p. 70.

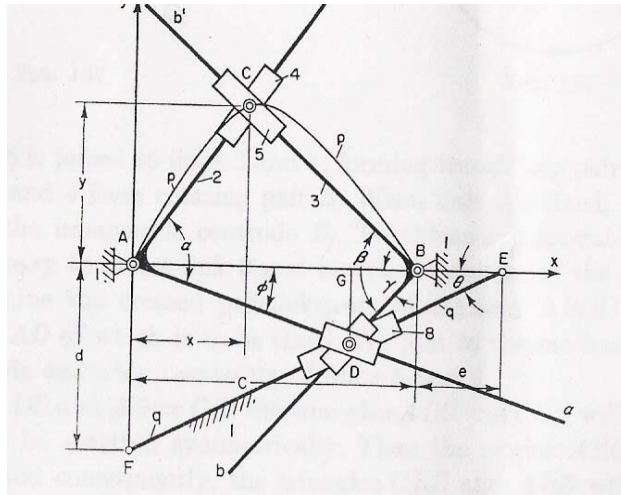

Figure 18. Boguslavskii's conicograph [Artobolevskii]

Alfred Bray Kempe (1849-1922) also formulated a famous theorem that any algebraic curve can be generated by an appropriate linkage or you can say simply: it is possible to design a linkage, which will sign your name (as long as your signature is the union of continuous curves).

Outline of a proof of Kempe's Theorem: Let the equation of the algebraic curve in implicit form, having the general form $f(x, y) = 0$ be expressed in the following form $\sum A_{mn} x^m y^n = 0$ where the A_{mn} are fixed constants. The generation of the curve representing this given equation reduces to the series of mathematical operations fulfilled by the individual mechanisms, which are joined together in the general unknown kinematic chain. Those individual mechanisms are:

1. mechanism for conveying a point along the given straight line;
2. mechanism for projecting a given point on to a given line;
3. mechanism which cuts off equal segments on the axes Ox and Oy;
4. mechanism for causing a straight line to pass through a given point and be parallel to a given line;
5. mechanism for obtaining proportional segments in two straight lines passing through a given point (multiplying mechanism);
6. mechanism for addition of two given segments (summing mechanism).

See [Artobolevski, p.8-12] for more details of this proof. See [Horsburgh, p. 260-261] for another proof of Kempe's Theorem.

Other Directions in the Theory of Linkages

In 1877 A. B. Kempe published a small book: *How to Draw a Straight Line: A Lecture on Linkages*. He mentioned J. Watt (1736-1819) and also the work of J. J. Sylvester (1814-1897),

Richard Roberts (1789-1864), P. L. Chebyshev (1821-1894), Harry Hart (1848-1920), William Kingdon Clifford (1845-1879), Jules Antoine Lissajous (1822-1880), Samuel Roberts (1827-1913), and Arthur Cayley (1821-1895). More about this see [Kempe].

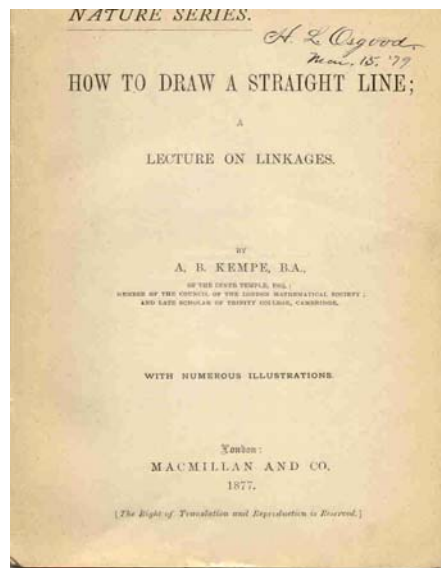

Figure 19. Title page of Kempe's book

This tradition of seeing curves as the result of geometrical actions can be found also in works of Roberval (1602-1675), Pascal (1623-1662), and Leibniz (164-1716). Mechanical devices for drawing curves played a fundamental role in creating new symbolic languages (for example, calculus) and establishing their viability. The tangents, areas and arc length associated with many curves were known before any algebraic equations were written. Critical experiments using curves allowed for the coordination of algebraic representations with independently established results from geometry [Dennis, 1995].

Linkages are closely related with kinematics or geometry of motion. First it was the random growth of machines and mechanisms under the pressure of necessity. Much later algebraic speculations on the generation of curves were applied to physical problems. Two great figures appeared in 18th century, Leonard Euler (1707-1783) and James Watt (1736-1819). Although their lives overlap there was no known contact between them. But both of them were involved with “geometry of motion”. Euler’s “Mechanica sive motus scientia analytice exposita” (1736-1742) is, to quote Lagrange, “the first great work in which analysis is applied to the science of movement.” The fundamental idea of kinematic analysis stems from Euler. Watt, instrument maker and engineer, was concerned with the synthesis of movement. Mechanism designers before Watt had confined their attention to the motions of links attached to the frame. It was Watt who focused on the motion of a point on the intermediate link of the four-bar mechanism in 1784. The application of this brilliant thought allowed Watt to build a double-acting steam engine; the earlier chain connecting piston and beam was now replaced by a linkage able to transmit force in two directions instead of only one. Euler’s theoretical results were unnoticed by kinematicians for another century. But engineers and mathematicians were devising linkages to compete or supersede Watt’s mechanism. These efforts led to generalized treatment of coupler-

point motion that first was called “ three-bar motion” and was developed by Samuel Roberts a century later.

Euler wrote in 1775:

The investigation of the motion of a rigid body may be conveniently separated into two parts, the one geometrical, the other mechanical. In the first part, the transference of the body from a given position to any other position must be investigated without respect to the causes of motion, and must be represented by analytical formulae, which will define the position of each point of the body. This investigation will therefore be referable solely to geometry, or rather to stereotomy. [Euler], page viii.

It is clear that by the separation of this part of the question from the other, which belongs properly to mechanics, the determination of the motion from dynamical principles will be made much easier than if the two parts were undertaken conjointly.

Here we can see beginnings of the separation of the general problem of dynamics into kinematics and kinetics. Euler’s contemporaries I. Kant and D’Alambert (1717-1783) also were treating motion purely geometrically. This is what L.N.M. Carnot (1753-1823) later called “geometric” motion. By the end of 18th century G. Monge (1746-1818) proposed a course on elements of machines for the Ecole Polytechnique

Linkages have many different functions, which can be classified according on the primary goal of the mechanism:

- a) function generation: the relative motion between the links connected to the frame,
- b) motion generation: the motion of the coupler link or
- c) path generation: the path of a tracer point.

The last category is a classical problem in linkage design where the primary concern has been the generation of straight-line paths. Franz Reuleaux (1829-1905), who is often called "father of modern machine design", had many of straight line mechanisms in his kinematic model collection. Cornell University has a collection with about 220 different F. Reuleaux kinematic models and 39 of them are mechanisms about straight-line motion. See [KMODDL].

In 20th century ideas growing from Kempe's work were further generalized by Denis Jordan, Michael Kapovich, Henry King, John Millson, Warren Smith, Marcel Steiner and others. The more recent combinatorial approach to linkages puts together ideas about rigidity, graph theory, and discrete geometry. One can generalize and consider a polygon (where the edges are hinged at the vertices), a tree, or other more general structures consisting of rods and plates (polygons spanned with a rigid membrane). The concept of a linkage is an area of mathematics that became dormant for a time, but has been recently revived by new applications.

Antonin Svoboda (1907-1980) became involved with computers in 1937 when he started to work for Czechoslovakian Ministry of National defense. He and Vand designed an anti-aircraft gun control system. In 1941 became a staff member of the Radiation Laboratory joining the group of the analog computers connected with MARK 56 anti-aircraft control. The analog computer had two sections. The linear part, which was called OMAR, was done by linear potentiometers of high precision (better than one- thousandth). But the linear theory had to be corrected by nonlinear corrections. Svoboda was asked to produce a mechanical solution for the non-linear part of the system. Computing linkages generating functions of one or two variables were

supposed to be used. See Figure 20 for example of a linkage computer such as Svoboda designed.

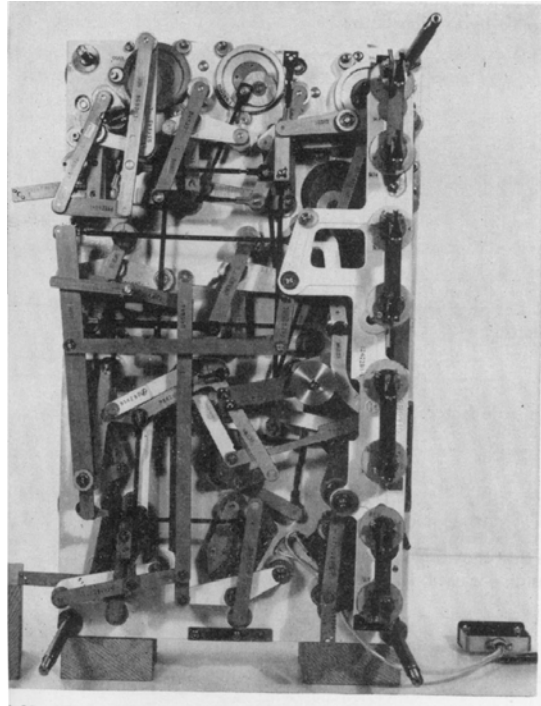

Figure 20. Linkage Computer [Hinkle]

For a recent survey of results on linkages, including some results since 2000, see [Connelly].

Bibliography (References in the paper and other general works on linkages)

Agricola, Georg. *De re metallica*. Translated from the first Latin ed. of 1556, with biographical introd., annotations, and appendices upon the development of mining methods, metallurgical processes, geology, mineralogy & mining law from the earliest times to the 16th century, by Herbert Clark Hoover and Lou Henry Hoover, New York, Dover Publications, 1950.

Ahrendt M. H. A General Method For The Construction Of A Mechanical Inversor, *Mathematics Teacher*, 37, (1944) 75 - 80.

Artobolevskii I. I., *Mechanisms for the Generation of Plane Curves*, Pergamon Press, New York, 1964.

Besant W. H., *Conic Sections Treated Geometrically*, London, 1895, – electronically from Cornell Math Library <http://historical.library.cornell.edu/cgi-bin/cul.math/docviewer?did=00630002&seq=11>

Besson, Jacques, Dauphinois. Uniform Title: *Theatrum instrumentorum et machinarum*. French Title: *Theatre des instrumens mathematiques et mechaniques de Iaques Besson ... : avec l'interpretation des figures d'icelui // par François Beroald ; plus en ceste derniere edition ont esté adioustees additions à chacune figure*. Publisher: A Lyon : Par Iaques Chouët, 1596..

Connelly, Robert, Demaine, Eric D., Rote, Gunter Straightening Polygonal Arcs and Convexifying Polygonal Cycles in *Discrete Comput Geom*30: 205-239 (2003).

Coolidge, Julian Lowell, *A history of the conic sections and quadric surfaces*, The Clarendon press, Oxford, 1945.

dduke, <http://www.csit.fsu.edu/~dduke/models>

Dennis, David *Historical Perspectives for the Reform of Mathematics Curriculum: Geometric Curve Drawing Devices and Their Role in the Transition to an Algebraic Description of Functions*, PhD Dissertation, Cornell University, May 1995.

Descartes, Rene, *La Geometrie*, Paris, 1886. <http://historical.library.cornell.edu/cgi-bin/cul.math/docviewer?did=00570001&seq=7>

Dürer, Albrecht, *Institutionum geometricarum libri quatuor ...*, Arnheimiae in Ducatu Geldriae : Ex officina Iohannis Iansonii ..., 1605.

Dyck, Walter *Katalog mathematischer und mathematisch-physikalischer Modelle, Apparate und Instrumente*, Georg Olms Verlag, Zurich, New York, 1994

Eagles, T. H. *Constructive geometry of plane curves*. With numerous examples, by T. H. Eagles, 1885 In Univ. of Michigan Historical Math collection: <http://www.hti.umich.edu/cgi/t/text/text-idx?c=umhistmath;tpl=home.tpl>

Easton, Joy B., Johan de Witt kinematical constructions of the conics, *The Mathematics Teacher*, December 1963, pp. 632-635.

Euler, Leonard, "Novi commentarii Academiae Petrop.," vol. XX, 1775; also in "Theoris motus corporum," 1790. The translation is by Willis, "Principles of Mechanism," 2d ed., p. viii, 1870

Fergusson, Eugene S., Kinematics of Mechanisms from the Time of Watt, *United States National Museum Bulletin* 228, Smithsonian Institute, Washington D.C., 1962, pp. 185-230.

Field, Peter, *Projective geometry, with applications to engineering*, Van Nostrand Company, New York, 1923 online in University of Michigan Historical Math Collection: <http://www.hti.umich.edu/cgi/t/text/text-idx?sid=8675e87426e349a1d439e95a34ae01fd;c=umhistmath;idno=ACV3228.0001.001>

Galle A., *Matematische Instrumente*, Teubner Verlag, Leipzig und Berlin, 1912. Online in Cornell Library Historical Math Collection: <http://historical.library.cornell.edu/cgi-bin/cul.math/docviewer?did=03650002&seq=7>

Hartenberg, Richard S., Denavit, Jacques, *Kinematic Synthesis of Linkages*, Mc Graw Hill Book Company, 1964.

Henderson, D., Taimina, D. *Experiencing Geometry: Euclidean and non-Euclidean with Strands of History*, 3rd ed., Prentice Hall, NY, 2005.

Hilsenrath, Joseph, Linkages, *Mathematics Teacher*, 30, (1937) 277 - 284.

Hinkle, Roland T., *Kinematics of Machines*, 2nd Ed., Prentice Hall, Englewood Cliffs, NJ, 1960.

Honnecourt, *The sketchbook of Villard de Honnecourt*. Edited by Theodore Bowie. Published: Bloomington, Indiana University; distributed by G. Wittenborn, New York, c1959.

Hopcroft, J., Joseph, D., Whitesides, S., Movement problems for 2-Dimensional Linkages, *SIAM J. Comput.* Vol. 13, No.3, August 1984.

Horsburgh, E. M., editor, *Modern Instruments and Methods of Calculation*, A Hyandbook of the Napier Tercentenary Exhibition, G. Bell and Sons and The Royal Society of Edinburgh, London, available online at : <http://historical.library.cornell.edu/cgi-bin/cul.math/docviewer?did=03640002&seq=7>

Kanayma, Raku. Bibliography on the Theory of Linkages, *Tohoku Mathematical Journal*, 37 (1933) 294-319.

Kempe, A. B., *How to Draw a Straight Line*, London: Macmillan and Co. 1877.

KMODDL, www.kmoddl.cornell.edu

Lloyd, Daniel B., The Teaching Of "Flexible" Geometry, *Mathematics teacher*, 32, (1939) 321 - 323.

Mathworld, <http://mathworld.wolfram.com/TusiCouple.html>

McCarthy J. M., *Geometric Design of Linkages*, Springer, New York, 2000.

Meserve, Bruce E., Linkages As Visual Aids, *Mathematics Teacher*, 39, (1946) 372 - 379.

Moon, Francis C., tutorial "How to draw an ellipse", see: KMODDL

Schooten, Frans van, *Mathematische oeffeningen : begrepen in vijf boecken*. Amsterdam : Gerrit van Goedesbergh, 1659-60

Svoboda A., *Computing Mechanisms and Linkages*, Dover, New York, 1965.

Taylor, Charles, *An introduction to the ancient and modern geometry of conics, being a geometrical treatise on the conic sections with a collection of problems and historical notes and prolegomena*
http://historical.library.cornell.edu/math/math_T.html

Yates, Robert C., The Story Of The Parallelogram, *Mathematics Teacher*, 33, (1940) 301 - 309.

Yates, Robert C., *Tools: A Mathematical Sketch and Model Book*, Louisiana State University, 1941.

Useful Web pages on linkages and their use in drawing curves:

http://www.pandd.demon.nl/cabrijava/cardlink_m.htm

<http://www.pandd.demon.nl/peaucel.htm>

<http://carol.wins.uva.nl/~leo/lego/linkages.html>

<http://www.museo.unimo.it/labmat/usa1.htm>

<http://www15.addr.com/~dscher/>

<http://www.nas.com/~kunkel/linkage/linkage.htm>

http://www.museo.unimo.it/theatrum/macchine/_00biblio.htm